

Introduction to SolidWorks 2009

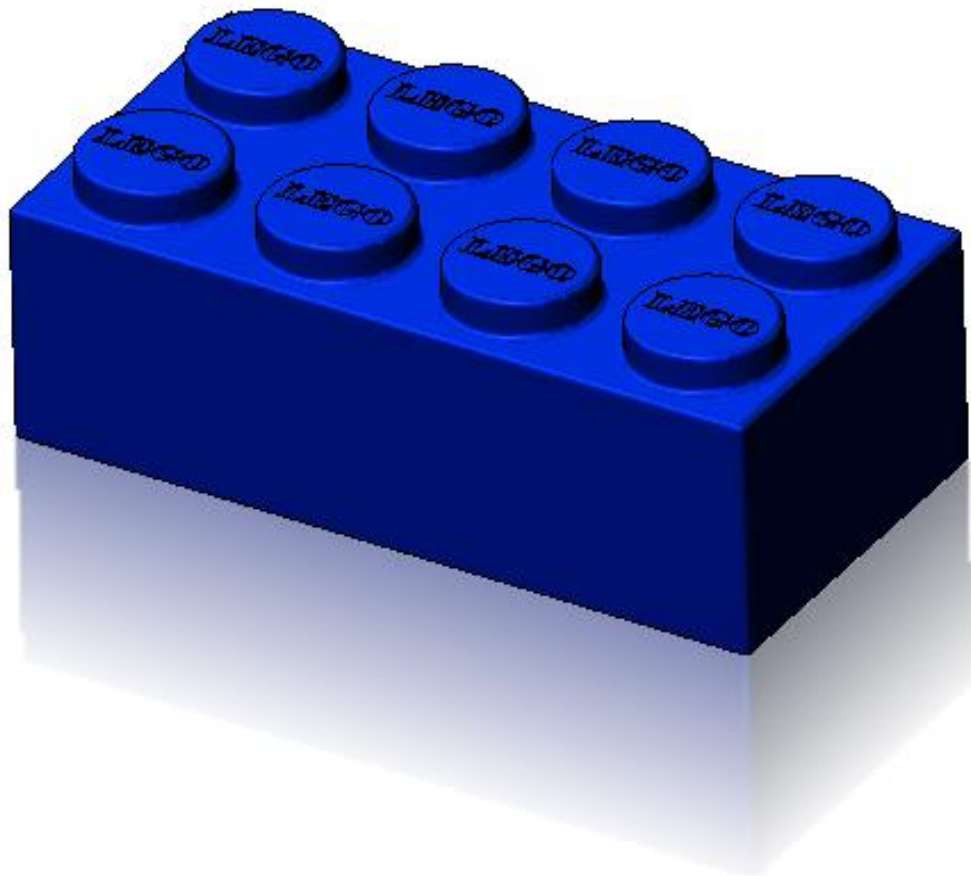

**TECHNOLOGY
SUBJECTS
SUPPORT
SERVICE**

Getting started

The first part that you will build is a Lego Brick. To begin building the part, you need to open a new SolidWorks part document. The new part document will be created based on a template. A template forms the foundation of a new document. The template can include user-defined parameters, annotations, or geometry. Templates allow you to define your only specific parameters, and then open new documents with those customised settings already set.

In this way, you define parameters only once and the new documents are created with the customised settings. This saves a lot of repetitive work each time you use SolidWorks

Note: The Sensors (*only available in SW's 2009*) tool located in the FeatureManager monitors selected properties in a part or assembly and alerts you when they deviate from a pre-specified limit. There are four sensor types: *Mass properties, Measurement, Interference Detection and Simulation data.*

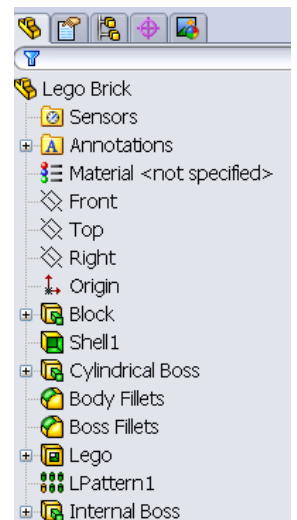
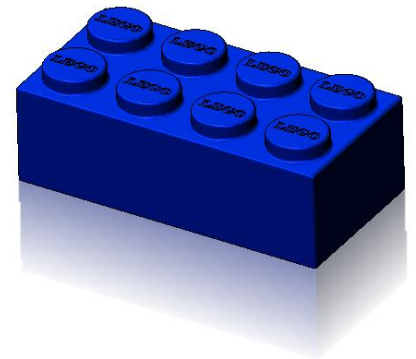

Starting SolidWorks and Opening a New Part

Start the SolidWorks application.

Click the **Start** menu from the Windows interface.

Click **All Programs, SolidWorks 2008, SolidWorks 2008.**

Tip: You can quickly start a SolidWorks session by double-clicking the left mouse button on the desktop shortcut, if there is a shortcut icon on the system desktop.



Open a new part.

Click **New**  from the Menu Bar toolbar. The New SolidWorks Document dialog box is displayed.

Note: When SolidWorks 2008/09 is installed it automatically references the templates from 2006.

Click the **Part** template

Click **OK** from the New SolidWorks Document dialog box. A new Part document window is displayed.

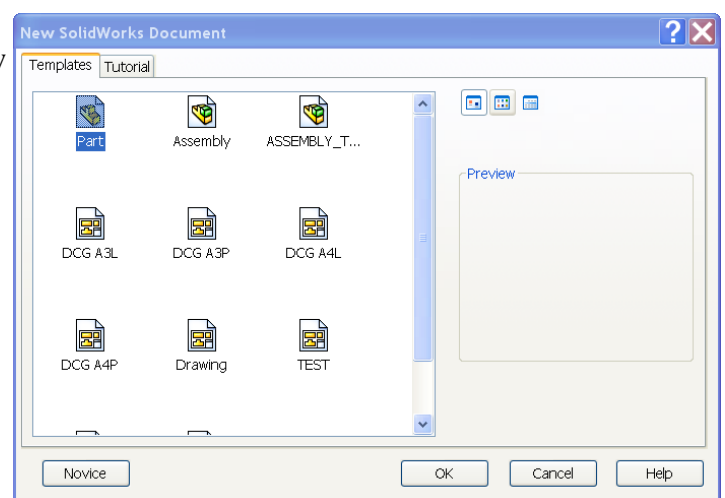

Set System units.

Click **Options** , **Document Properties** tab from the Menu Bar toolbar. The Document Properties - Drafting Standard dialog box is displayed.

ANSI is the default Overall drafting standard.

Click **Units**. Select **MMGS**, (millimeter, gram, second).

Click inside the **Length Decimals** box. Select **.12** decimal places from the dropdown menu for Basic unit length. Accept the default settings.

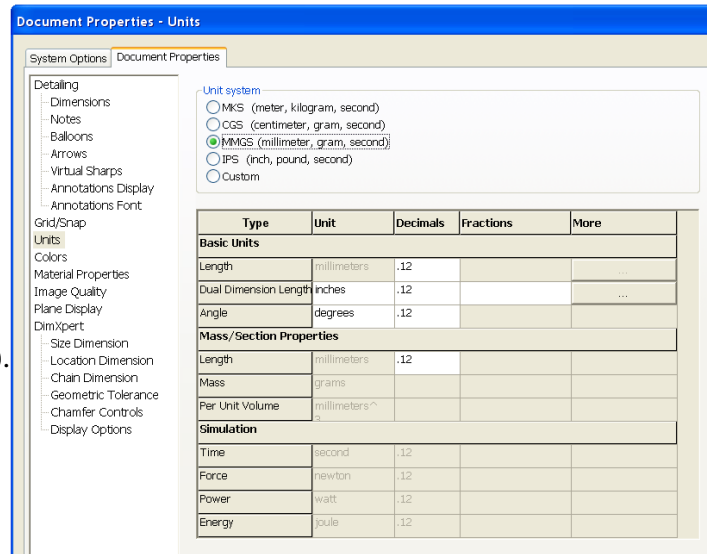

Click OK from the Document Properties - Units dialog box. Return to the SolidWorks Graphics area.

Begin Sketching

Solid models are built from features. Initially, features are based on 2D sketches. The sketch is the basis for a 3D model. Create a 2D sketch that you will later make into a 3D solid.

Sketches are flat or planar. In the same way as we need a sheet of paper on which to sketch you need to choose a plane on which to sketch in SolidWorks. A SolidWorks part contains three default sketch planes. They represent the Front, Top, and Right planes.

Left click on the Top plane and choose **Sketch** 

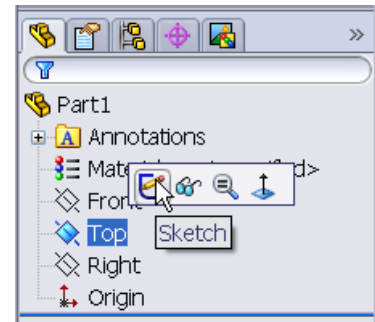

Choose **S** on the keyboard. A context sensitive toolbar appears with a variety of sketch tools.

Note: The toolbar appears where the cursor was last clicked.



Similar commands are grouped into consolidated flyout buttons on the toolbar.

These buttons appear with an arrow next to them eg. Rectangle.

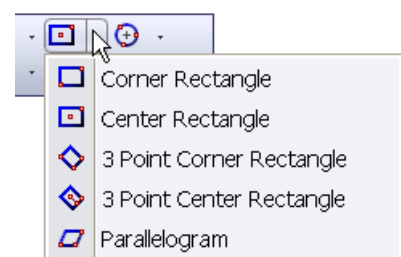

Click the **Centre Rectangle** tool  from the shortcut toolbar. The Rectangle PropertyManager is displayed. The Centre Rectangle tool  is displayed on the mouse icon.

Place the centre of the rectangle on the origin and drag the rectangle as shown.

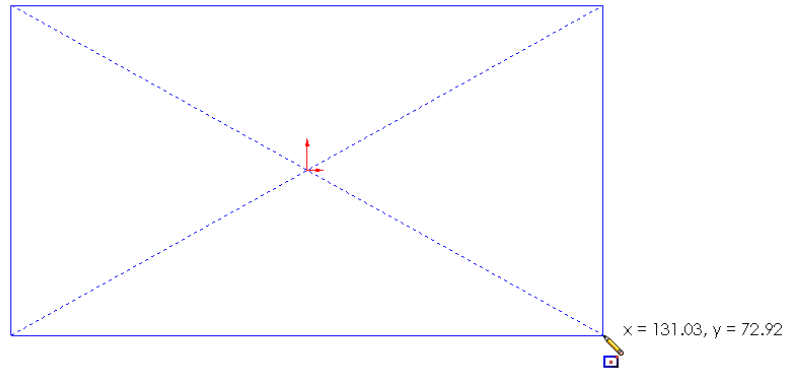

Left click in the graphics area to position the rectangle.

Press **Esc** on the keyboard to exit the command

Zoom to fit.

Press the **f** key on the keyboard to return to the full Graphics area.

Note: The horizontal and coincident geometrical relations are automatically added.

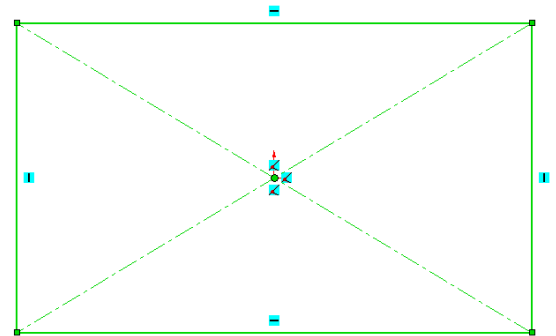

Smart Dimension

Choose **S** to activate the shortcut toolbar and choose **Smart Dimension**  .

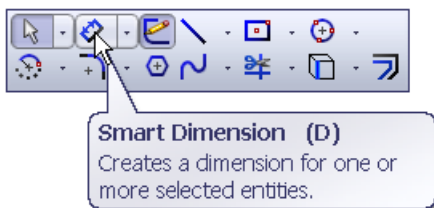

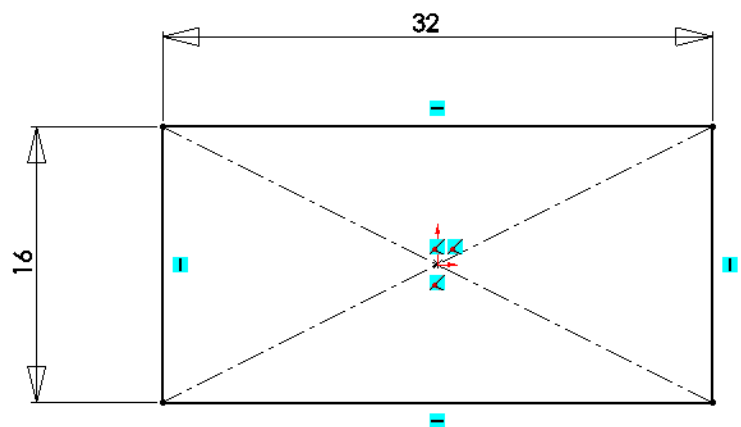

Add the dimensions shown across.

The sketch turns black and is fully defined



Exiting the sketch.

Three options exist to exit the sketch. As in SolidWorks 2006 you may exit the sketch by choosing

Exit Sketch  from the confirmation corner or choose **Exit Sketch**  from the **CommandManager**

The third option, new to SW 2008, is to double left click on a blank space in the graphics area

Accessing a sketch to edit it.

If you wish to edit an existing sketch left click on the sketch in the feature manager and choose **Edit Sketch** 

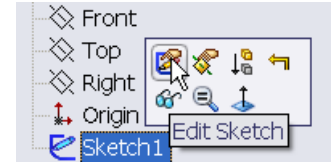

Renaming features on creation

To enable this feature **Choose Tools, Options, FeatureManager – Name feature on creation**



Extruding the Lego Brick.

The extrude tool may be accessed in two ways.

1. Click the **Features** tab from the CommandManager. The Features toolbar is displayed. Select the **Extruded Boss/Base** tool. The Extrude PropertyManager is displayed



or

2. Choose **S** on the keyboard. The context sensitive toolbar appears with appropriate feature tools available. Choose **Extruded Boss/Base**

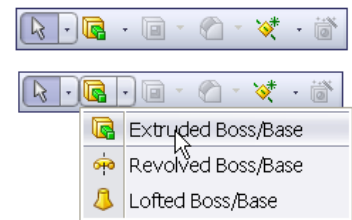

Set the End Condition and Depth.

Select **Blind** for End Condition in Direction 1. Enter a **Depth** of 10mm.

You can use the up and down arrow buttons next to the Depth box to change the value by 10mms (default in system options) at a time.

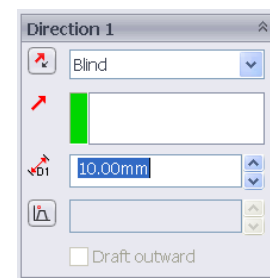

Click **OK** from the Extrude PropertyManager. The Extrude1 feature is created.

Tip: Instant3D provides the ability to click and drag geometry and dimension manipulator points to resize or create features directly from the Graphics area. Use the on-screen ruler to measure your modifications.

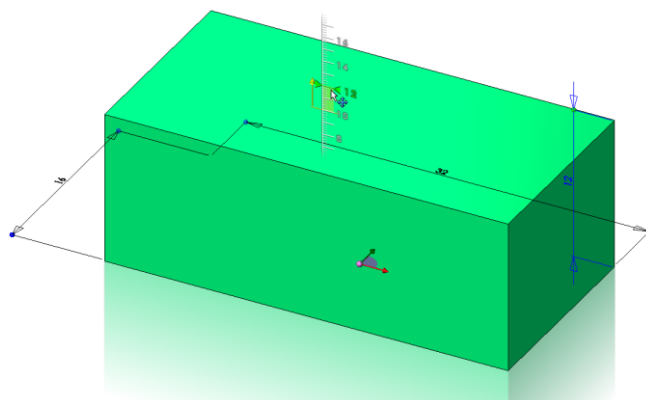

Using Instant3D

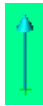
Double click on the top surface of the model. An arrow  will appear pointing upwards.

Click and hold the tip of the arrow with the left hand mouse button. Drag the cursor, a ruler will appear. Move the cursor over the ruler and drag the cursor to change the **Depth** of the extrude in realtime. Press **Esc** to exit Instant3D and record the changes.

Note: Ensure Instant 3D is enabled on the **Features** toolbar.

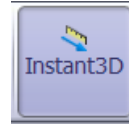

Enabled



Disabled

Note: Return the Depth of Extrude1 to 10mm to continue with the exercise.

Saving Your Work

Save the part document as **Lego Brick.sldprt**.

You can save your files as often as you wish. However, there are really only two situations that require you to save your work:

- After you have done something you want to keep.
- Before you try something that you are not sure will work.

Note: A file saved in a later version of SolidWorks cannot be opened in an earlier version i.e. A SolidWorks model created in SW2008 cannot be opened in SW2006.

Shell feature

To create a wall thickness of 1mm we use the **shell** command. The shell command may be chosen from the **commandmanager** by selecting the **features** tab *or* by using the **S** key on the keyboard

Note: When the **S** key is chosen the pop-up toolbar does not contain the shell command. However, the button may be added by right clicking on the toolbar and choose customise.



Choose the features category and drag the shell command to the toolbar.



The shell command will appear on the pop-up toolbar each time it is activated from then on.

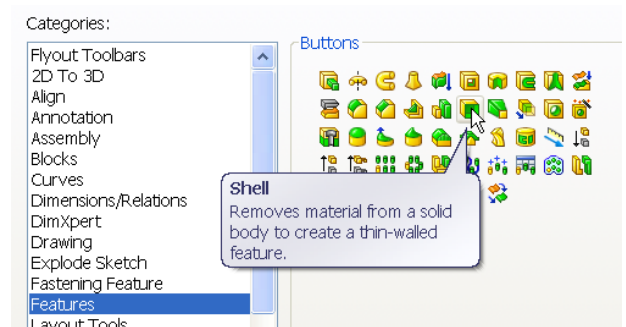

Insert **1mm** as **thickness** value for the walls of the Brick.

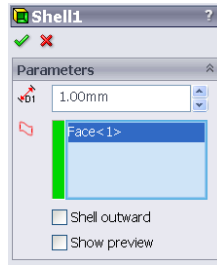

Choose the underneath of the Brick as **Faces to remove**.

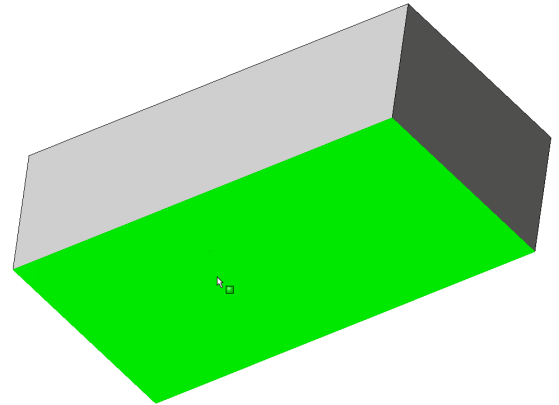

Choose **OK**.

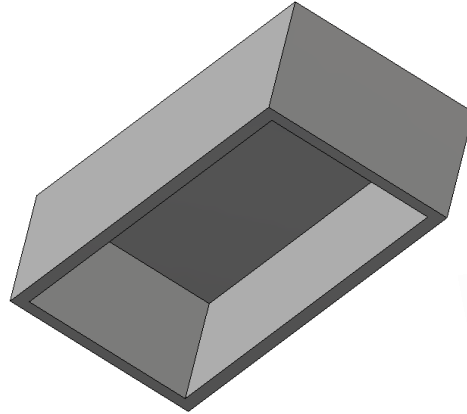

Choose **Isometric** from the **Heads-up View toolbar**



Isometric (Ctrl+7)
Rotates and zooms the model to the isometric view orientation.

Creating the cylindrical boss.

Right-click the **top face** of the Lego Brick. The top face is the Sketch plane and is highlighted in the Graphics area.

Click the **Sketch** tool from the Context toolbar.

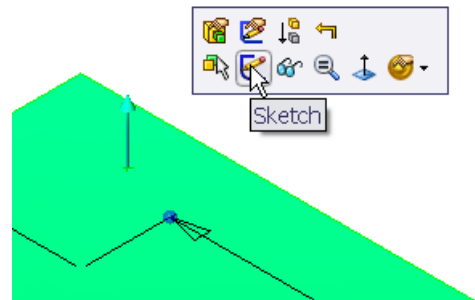

Choose **Normal to** from the heads up toolbar

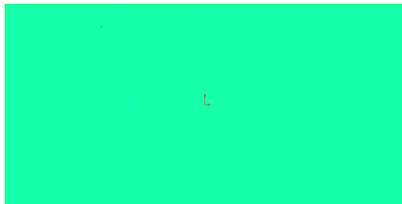

Normal To (Ctrl+B)
Rotates and zooms the model to the view orientation normal to the selected plane, planar face, or feature.

Choose **Hidden Lines Visible** from the heads up toolbar.



Hidden Lines Visible
Displays all edges of the model. Edges that are hidden from the current view are displayed in a different color or font.

Sketch a circle.

Click the **Circle** tool from the pop-up toolbar.
Circle PropertyManager is displayed.



Add the sketch as shown.

Add the tangent relations between the circle and the hidden detail edges as shown.

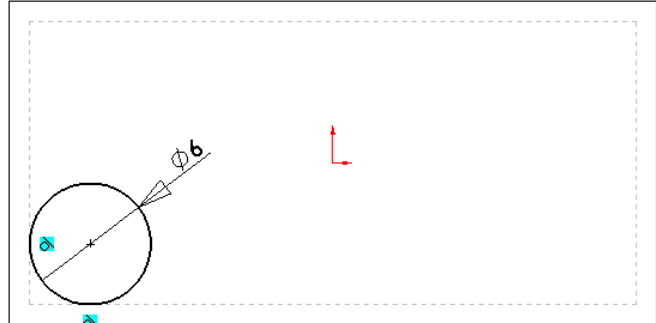

Smart dimension the circle to fully define the sketch.

Choose **Shaded with Edges** and **Isometric** from the heads up toolbar. **Exit the sketch**

Using Instant3D to create the Extruded Boss/Base

Click on the sketch in the graphics area, an arrow appears as shown.

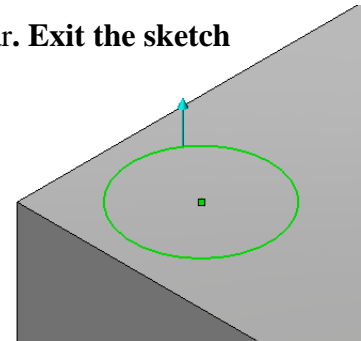

Click and drag the arrow, as described earlier, to a **Depth of 1.6mm.**

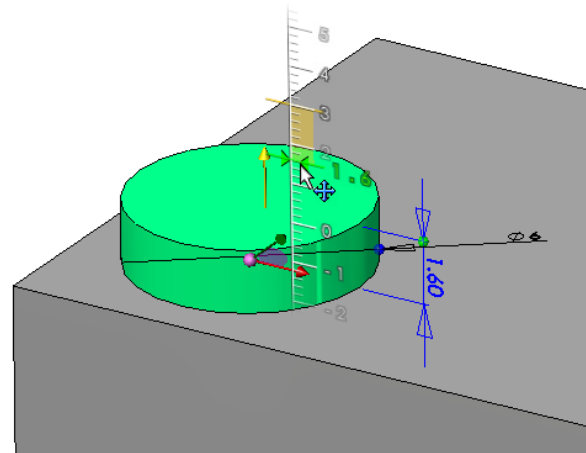

Press **Esc** to exit Instant3D. **Extrude 2** is created in the FeatureManager.

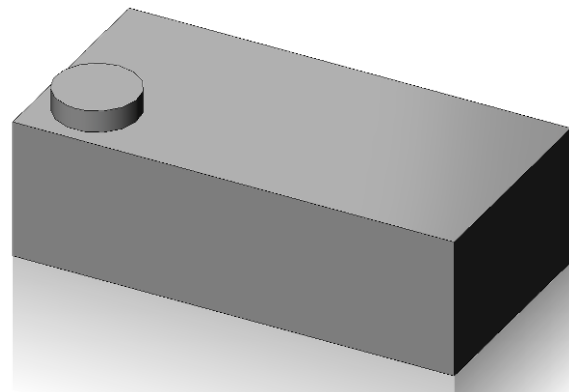
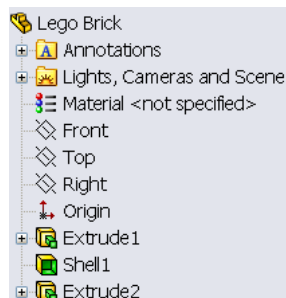

Tessellation

The display of geometry on your system may appear somewhat different from the illustrations. The lines may appear rougher. This is called tessellation. Tessellation or line display is related to the performance of the computer. Higher quality graphics or higher system settings will improve model appearance.

Choose **Tools, Options, Document Properties. Image Quality...**

Inserting a Fillet Feature

The **Fillet** feature rounds sharp edges and faces. We will use the **Fillet** feature to round the sharp edges of the Lego Brick. The Fillet feature requires an edge or face with a specified radius.

In general, it is best to follow these few rules when inserting a fillet:

1. Add larger fillets before smaller ones. When several fillets converge at a vertex, create the larger fillets first.
2. Add drafts before fillets. If you are creating a molded or cast part with many filleted edges and drafted surfaces, in most cases you should add the draft features before the fillets.
3. Save cosmetic fillets for last. Try to add cosmetic fillets after most other geometry is in place. If you add them earlier, it will take longer to rebuild the part.

Choose Fillet from the Pop-up toolbar

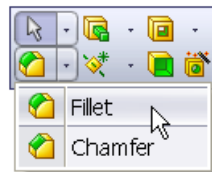

Two PropertyManager tabs are available:

1. **Manual.** Use this tab to maintain control at the feature level similar to the use of fillet command in SW2006.
2. **FilletXpert.** Use this tab when you want the SolidWorks software to manage the structure of the underlying features for a constant radius fillet.

Fillet / FilletXpert PropertyManager

The FilletXpert PropertyManager is displayed when you click the FilletXpert tab in the Fillet PropertyManager. The FilletXpert manages, organises, and reorders constant radius fillets. Use the **Add** tab to create new constant radius fillets.

Use the **Change** tab to modify existing fillets. Use the **Corner** tab to create and manage fillet corner features where exactly three filleted edges meet at a single vertex.

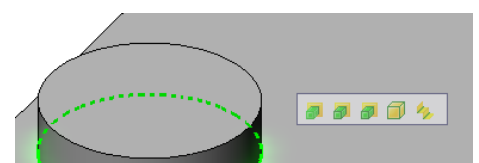
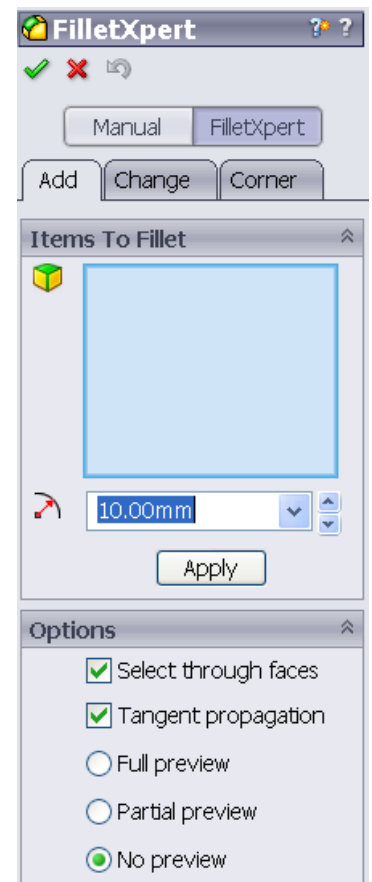

Choose the **FilletXpert** tab. Choose the **Add** tab.

Choose the edge at the base of the cylinder as shown. A context sensitive toolbar appears.

Moving the cursor over the buttons will select various other edges to add the fillet to. Choose the middle one. This will include the top edge of the cylinder in the selection.

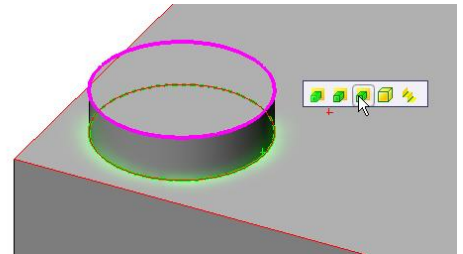

Choose a **Radius of 0.25mm.**

Choose **Full preview**

Choose **Apply**

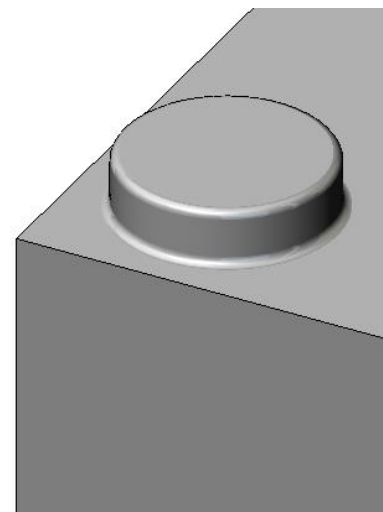
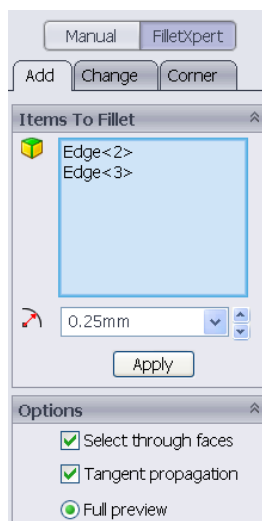

Choose the edges shown

Choose a **Radius of 0.1mm.**

Choose **Apply**

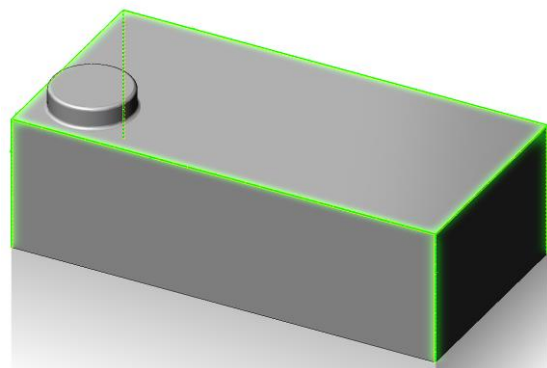
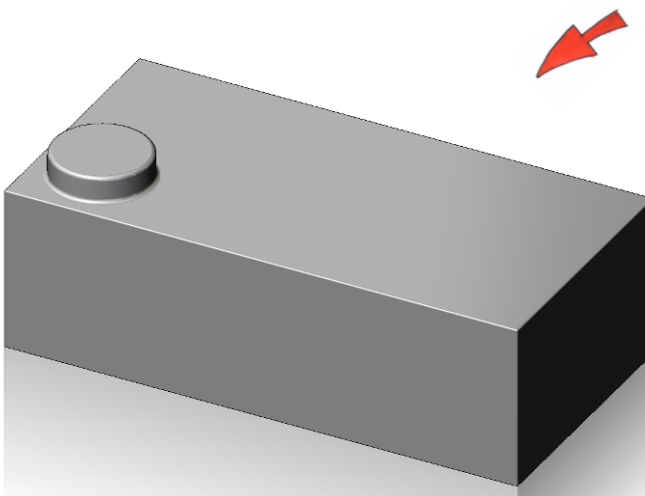

Editing Extrude2 feature using Instant3D

When modeling we commonly need to change features as we progress through the modeling stage.

To demonstrate the simplicity with which we can edit features using **Instant3D** we will edit the height of Extrude2.

Double click on the top face of **Extrude2**.

The **arrow** used to create the feature appears along with the **Depth dimension** of **1.6mm**.

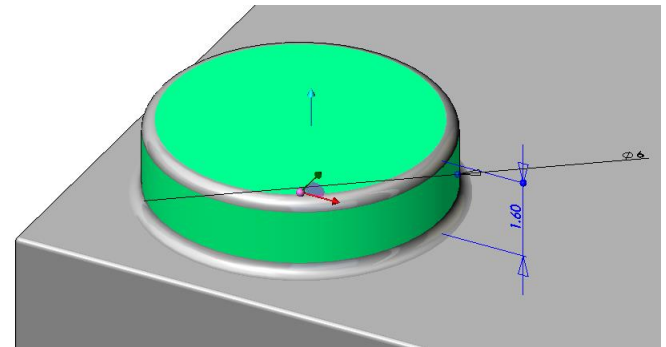

You may click and drag the arrow along the ruler, as Before, to change the feature **Depth** to **2mm**

or

Click on the circle on the extension line of the 1.6mm dimension.

Hold and drag the dimension along the ruler to a depth of **2mm**.

Press **Esc** to exit.

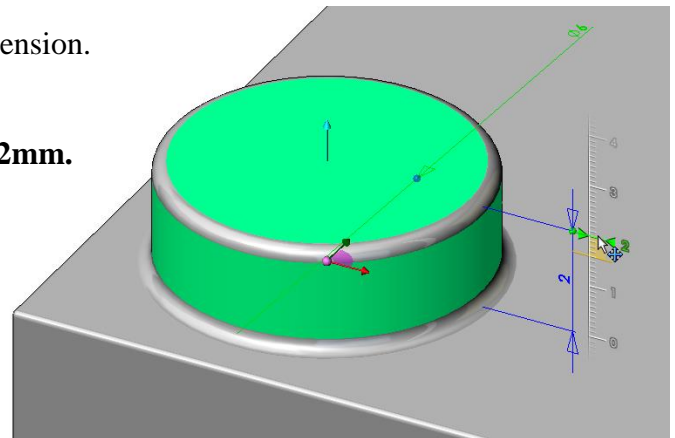

Adding “LEGO” text to the cylindrical face.

Select the top face of the cylinder and choose **Sketch**

Choose **Normal to** from the heads up toolbar.

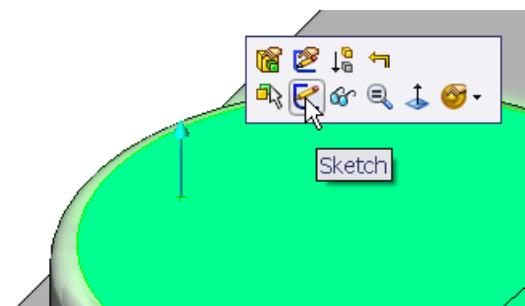

Choose **Centreline** from the context sensitive shortcut toolbar

Create the sketch shown ensuring to capture the automatic relations

Choose **Text**  from the Sketch tab in the commandmanager.

Choose the centerline as the text guide curve

Enter “**LEGO**” as the **Text**.

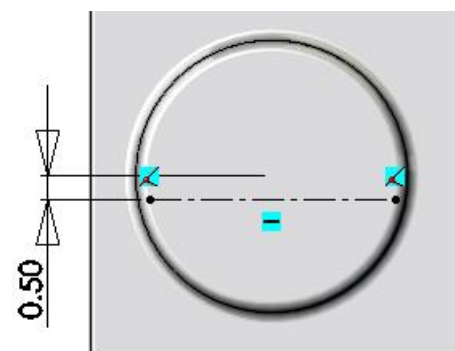

Uncheck “Use document font”. Select

Select **Elephant** as font type with a height of **1mm**. Choose **OK**.

Choose **Centre Align** to centre the text on the sketch line.

Select  . Exit the sketch as described earlier.

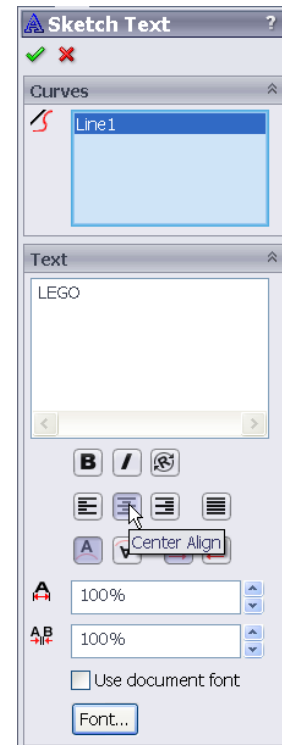

Creating the Extruded Cut

Choose **Extruded Cut** from the shortcut toolbar.

Choose the LEGO text sketch.

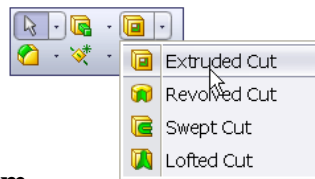

Choose a **Blind End Condition** to a **Depth of 0.1mm**

Choose **OK**

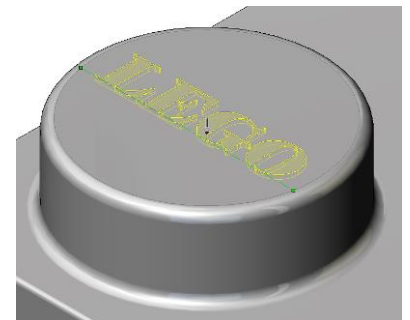

Note: **Extruded Cut** appears as

Extrude3 in the featuremanager and is only differentiated from the extruded boss/base, Extrude2, by its symbol.

 Extrude2 - **Extruded Boss/Base**

 Extrude3 - **Extruded Cut**

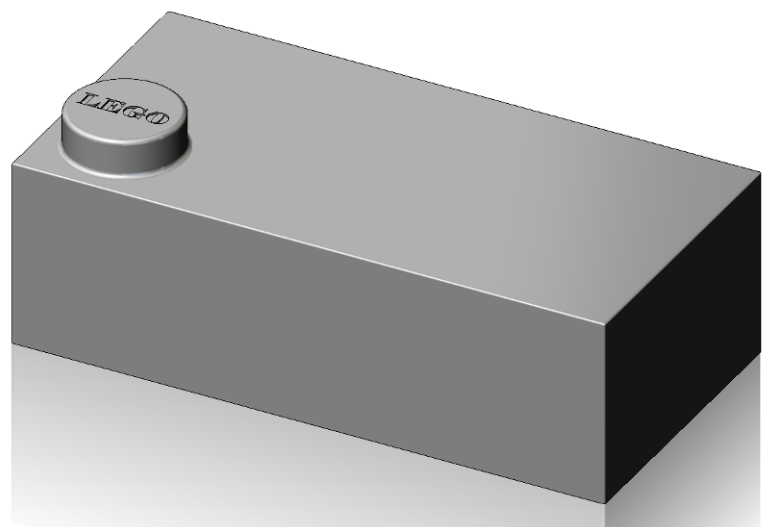

Pattern feature

The cylindrical feature along with the extruded text and fillets will now be copied to create a further seven features on the top of the Lego Brick.

Choose **Linear Pattern** from the feature tab in the commandmanager.

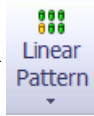

Choose **Extrude3, Fillet1** and **Extrude2** as features to pattern.

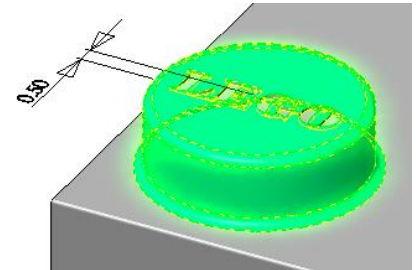
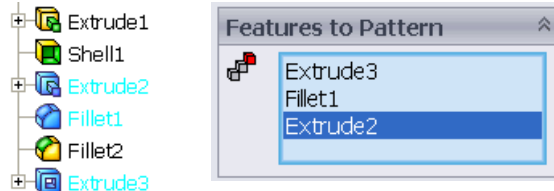

Choose **Directions, Number of Instances** and **Spacing** as outlined below.

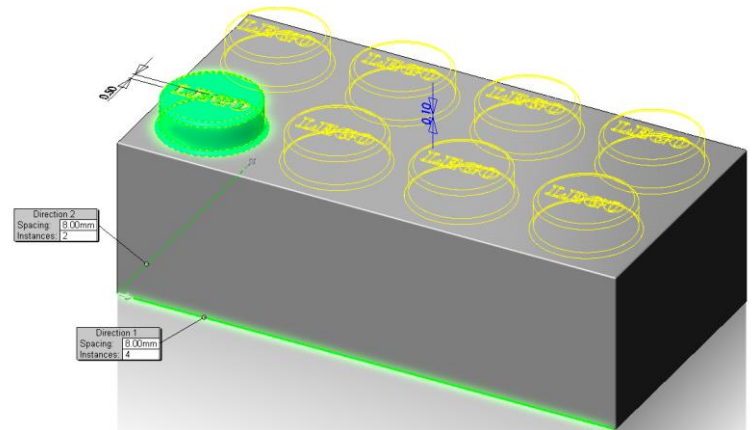
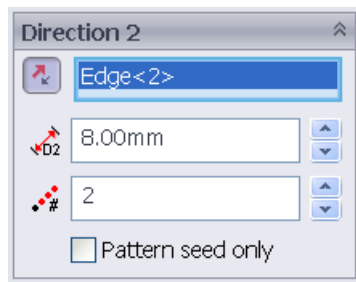
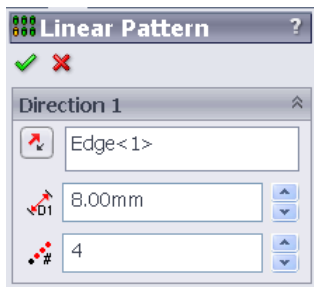

Choose **OK** 

Adding the features underneath.

Next we will add the features inside the Lego Brick.

These features allow the Bricks to assemble together and are therefore related to the cylindrical protrusions on the top of the Brick.

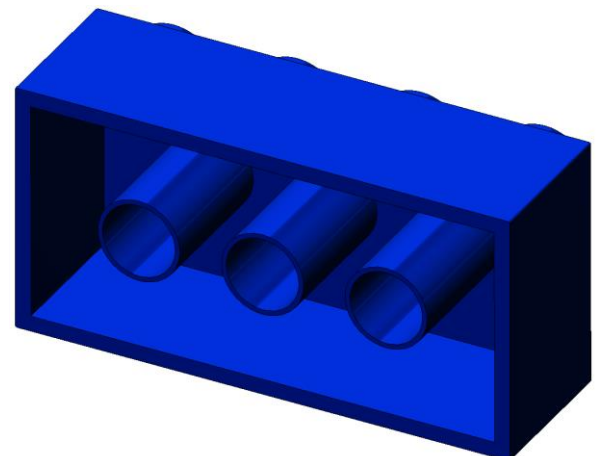

We will create a sketch on the underside of the top surface.

Choose **Bottom** view from the heads up toolbar.

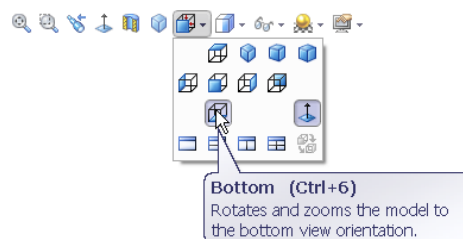

Choose **Wireframe** from the heads up toolbar.

The cylinders located underneath are located tangential to those on top and hence the Lego Bricks assemble correctly in relation to one another.

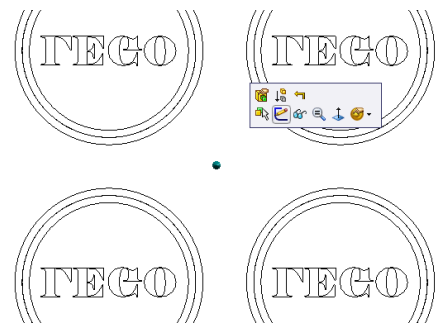
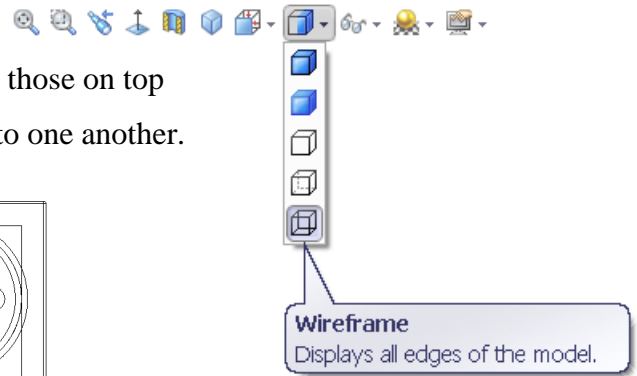
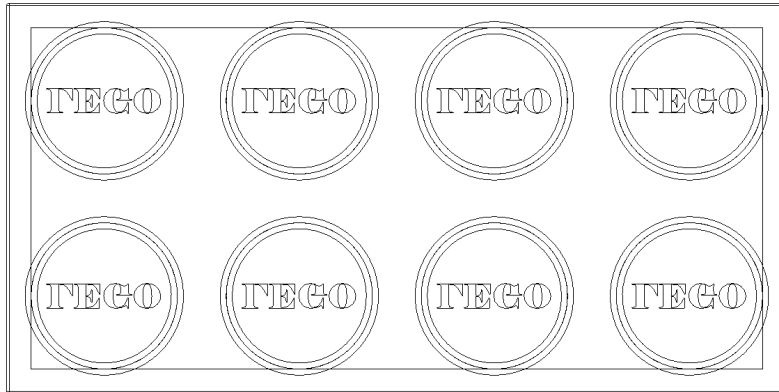

Click on the surface and choose **sketch**.

From the shortcut toolbar choose **Perimeter Circle**
Perimeter Circle generates a circle based on three points defining the circumference of the circle.

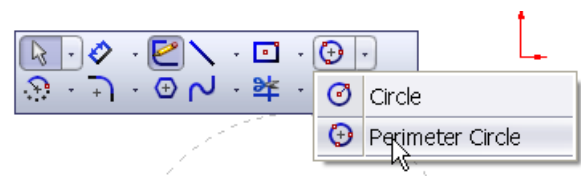

Choose the three points, as shown below, ensuring the circle is drawn tangential to the cylinders as shown.

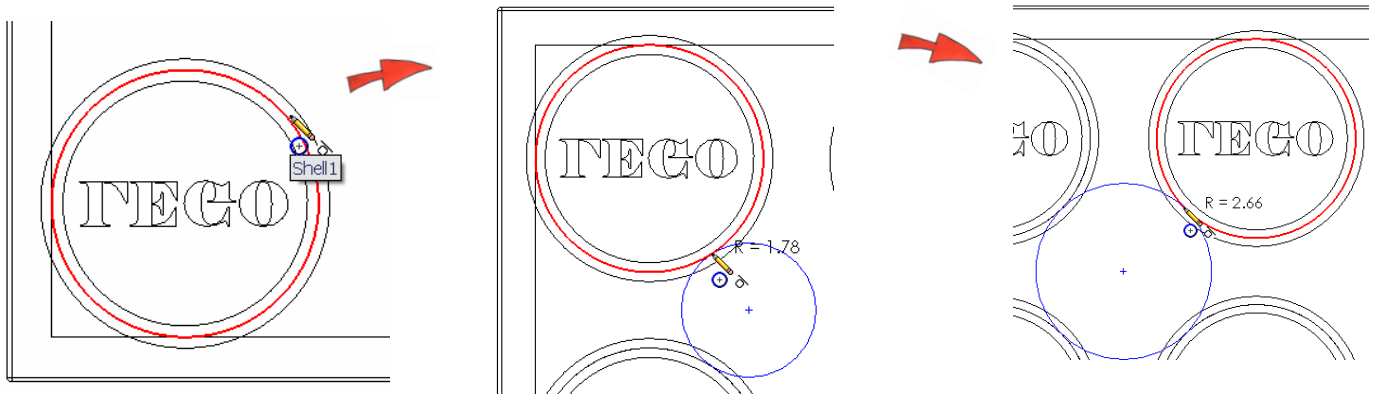

The circle remains blue and has yet to be defined.

Add a **Tangential Relation** between the circle and each of the other three circles.

The circle turns black – fully defined.

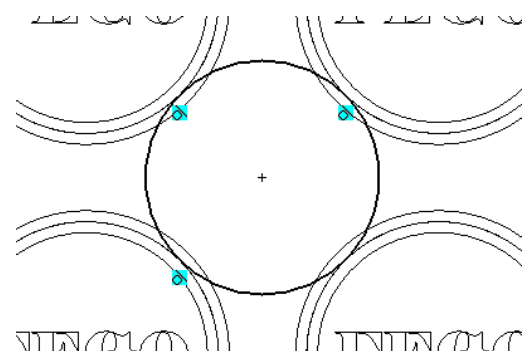

Repeat the process for the circle on the opposite side.

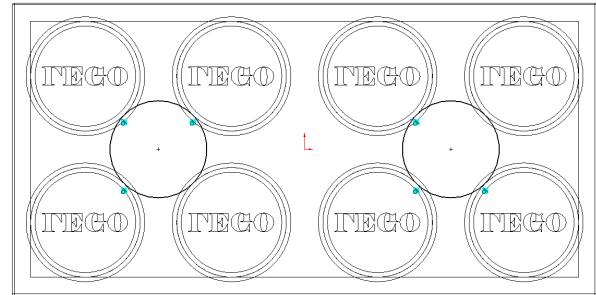

Circle coincident with the origin

To construct the third circle coincident with the origin we will use **Circle** command from the shortcut toolbar.



Create a circle with centre coincident with the origin and radius tangential to the cylinders on top.

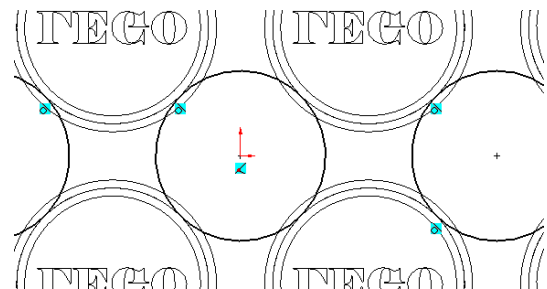

Note: The tangential relation will fully define the sketch.

The wall thickness of the cylindrical features is **0.3mm**. We will use the **offset** command to create this wall thickness.



Choose **Offset** from the shortcut toolbar

Choose the offset settings indicated below. Choose the 3 circles. Choose **OK**

Offset Entities
Adds sketch entities by offsetting faces, edges, curves, or sketch entities a specified distance.

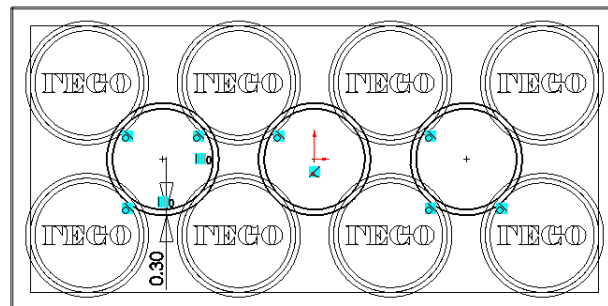
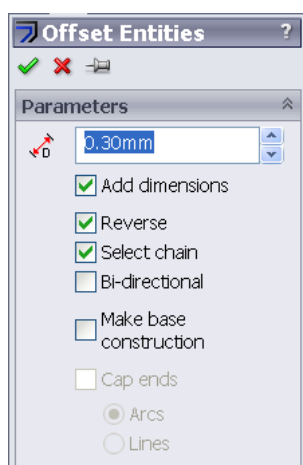

Choose **Shaded with Edges** from the heads up toolbar and rotate the model to the approximate position shown. Exit the sketch.

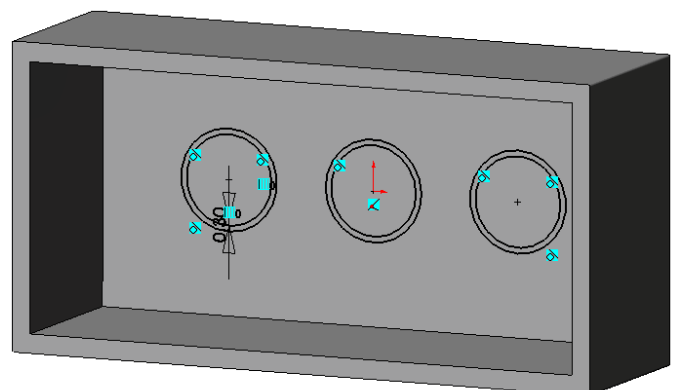

Creating the features.

Extrude the sketch with an **Up to Surface** end condition choosing the selected face as the **Face/Plane** up to which to extrude.

Choose **OK**

Choose **Isometric** from the heads up toolbar.

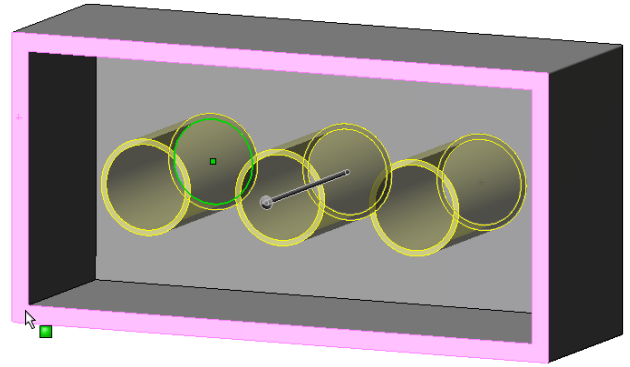

Editing the appearance of the Brick.

Edit Material

You can apply a material to a part, and create or edit a material with the **Materials Editor PropertyManager**. The material and its properties are used in COSMOSWorks, COSMOSXpress, PhotoWorks, Mass Properties and Material Properties. The response of the part depends on the material it is made from.

To edit a material right click on the part name on the top of the featuremanager design tree and choose **Appearance, Edit Material...** as in SolidWorks 2006.

Choose **Plastics, PVC Rigid**.

The Lego Brick now assumes all of its properties eg mass based on this material.

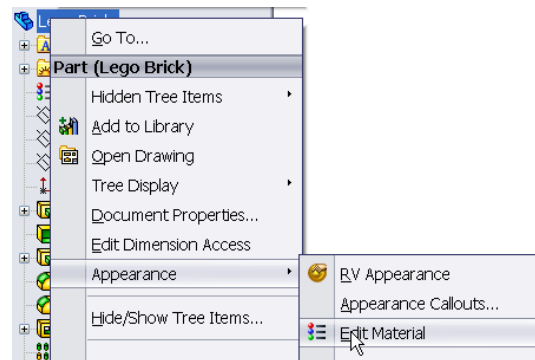

The mass etc of the part may be read from the **mass properties**.

Choose the **Evaluate** tab from the **CommandManager**.
Select **Mass Properties**.



These values are calculated based on the material assigned.

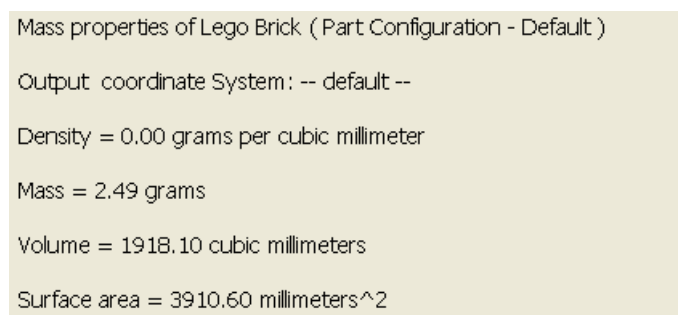



RealView Graphics

With RealView enabled appearance and scenes may be added to create photorealistic views of a model. RealView Graphics uses the graphics card to give more advanced shading in real time, when the model is rotated the rendering is retained.

Once a physical material has been applied RealView Graphics may be used to give the model a realistic appearance i.e. a steel physical material could be applied to a model, to facilitate physical properties, but it could then be enhanced with the appearance of glossy paint.

To enable **RealView** choose **View, Display, RealView Graphics...**

Note: The symbol used for RealView in 2008 is  whereas the symbol used in 2009 is . Some of the functionality has changed in 2009 and hence we will be approaching the area with 2009 functionality in mind. However, for the remainder of this exercise when accessing RealView we will refer to the 2008 symbol. 

Appearance

Appearances are the likeness of how a material would look without adding the physical properties.

A hierarchy exists when adding appearance to a model;

- Faces override all other instances in a model
- Features override bodies but not faces
- Bodies override documents



By default the model will appear in default plastic

Adding an appearance to the Lego Brick.



Right click on any face of the model and choose

Appearance Callout 

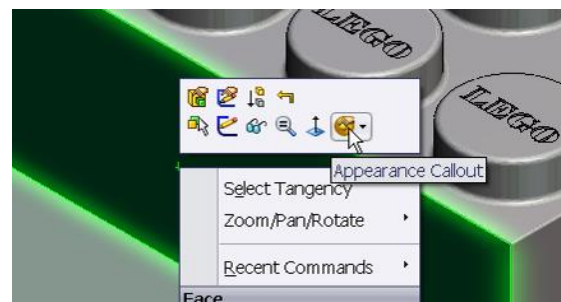
(Note: This icon will appear as  in SW 2009)



A drop-down menu appears with the various aspects of the model in hierarchical order.

Click on the colour swatch next to the part name, Lego brick.  Lego Brick 

The **RealView/PhotoWorks Tab** appears on the right hand side of the screen and the **Colors Appearance manager** on the left as shown overleaf.

A **preview window** appears to preview the resulting render.



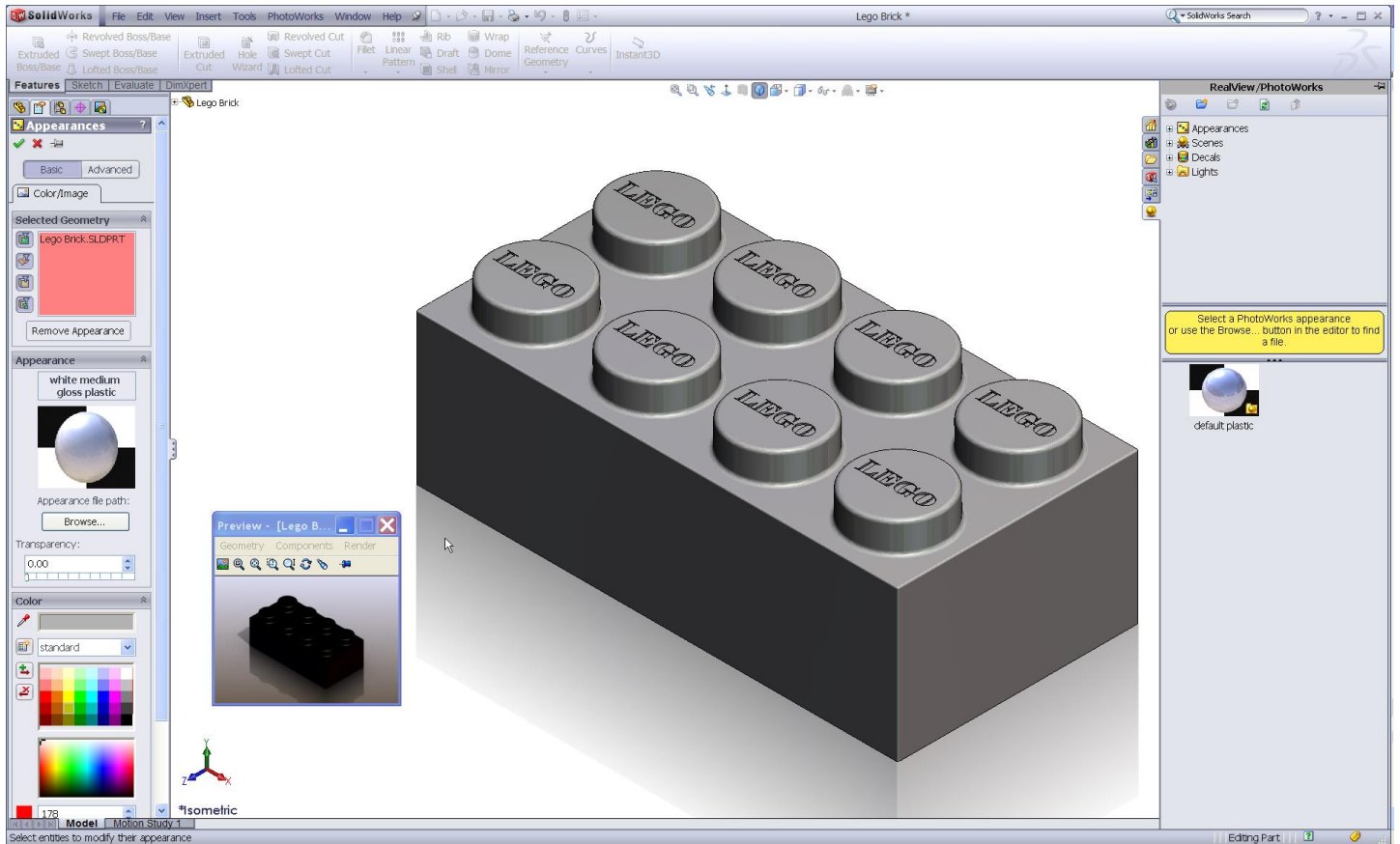

Within the RealView/PhotoWorks tab we can access appearances, scenes, decals and lights folders.

Choose **Appearances**. The categories are listed on top with the various options within each category displayed below.

Choose **Plastic, Medium Gloss, blue medium gloss plastic**.

The blue medium gloss plastic is applied to the entire part.

The colour may be changed by choosing from the colour swatch in the Appearance PropertyManager.

Choose **OK**

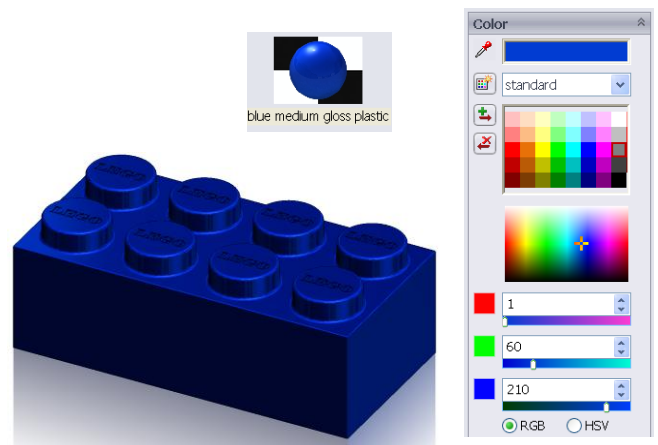

How do I apply a different colour to a face?

Right click on the face and choose **Appearance Callout**.

In the dropdown menu choose the **face** option.

Follow the same procedure as before for applying the colour.



Adding a scene

Document scene backgrounds are used to enhance appearances. Scenes are made up of a background and the addition of lighting. Within the task pane scenes are placed in three categories; Basic, Studio and Presentation.

Note: Earlier in the exercise we changed the background to plain white. We checked use plain background colour as opposed to the document scene background. Whilst this remains checked we cannot use the available scenes.

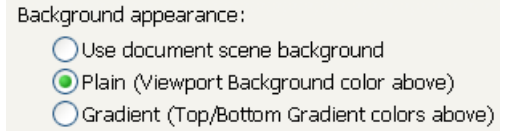

Choose **Options, System Options, Colors...**

and select **Use document scene background** as opposed to plain.

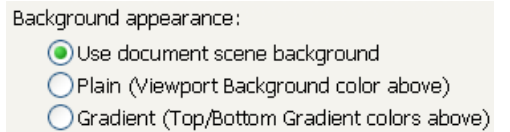

The default scene “**Light Cards**” will now be displayed.

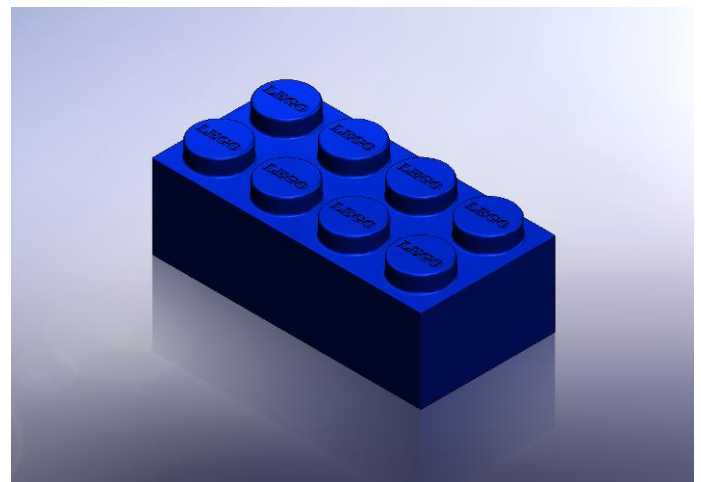

To view the various scenes choose  from the task pane. Choose **Scenes**.

Double click on any of the folder categories to display a preview of the various scenes within that category

Drag and drop the chosen scene from the task pane into the graphics area.

The background updates immediately to reflect the changes.

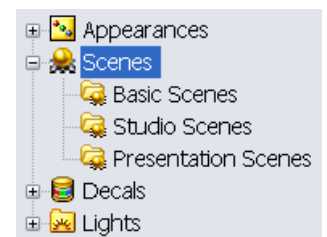

Investigate the various scenes available within the various categories by dragging and dropping them into the graphics area.

These scenes may also be accessed, without preview, under **Apply scene** on the heads up toolbar

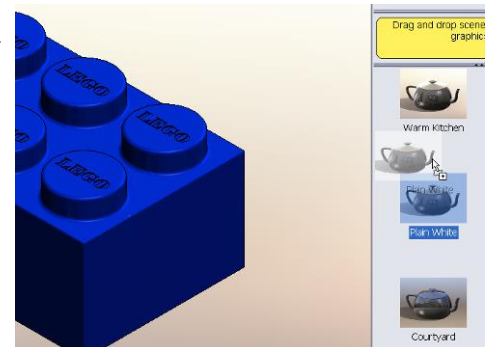
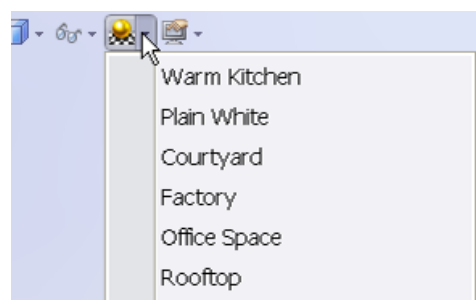

Note: A plain white background is available in the basic scenes folder, to facilitate screen grabs, saving as a jpeg etc.



Creating a drawing

SolidWorks allows you to create drawings from parts or assemblies. These drawings are fully associative with the parts and assemblies they reference. If dimension is changed on the finished drawing, that change propagates back to the model. Likewise, if the model is changed, the drawing updates automatically.

Drawings communicate three things about the objects they represent:

- **Shape** – Views communicate the shape of an object.
- **Size** – Dimensions communicate the size of an object.
- **Other information** – Notes communicate nongraphic information about manufacturing processes such as drill, ream, bore, paint, plate, grind, heat treatment, remove burrs, and so forth.

Select **New, Make Drawing from Part/Assembly**, from the standard toolbar.

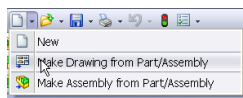

Choose the DCG A3L template from the available list.

The Drawing document is opened with the DCG A3L template displayed.

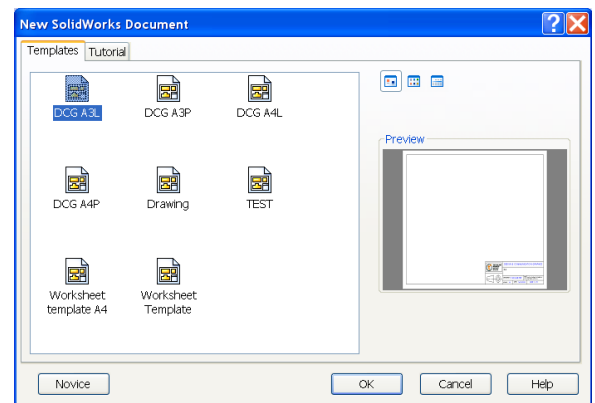

Note: To change the drawing paper to plain white choose;

Tools, Options, Colors, Drawings Paper Color

Select **Edit** and choose **White**. Choose **OK**.

Select **Use specified color for drawings paper color**

Choose **OK**

The drawing sheet will now be plain white.

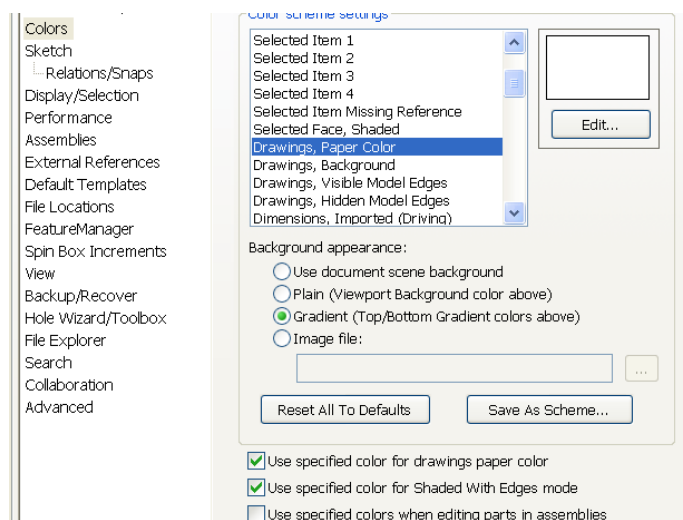

The view palette, located on the task pane may be used to insert drawings views.

Note: The **View Palette** tab  provides the ability to click and drag drawing views into an active sheet. The View Palette contains images of standard views, annotation views, section views.

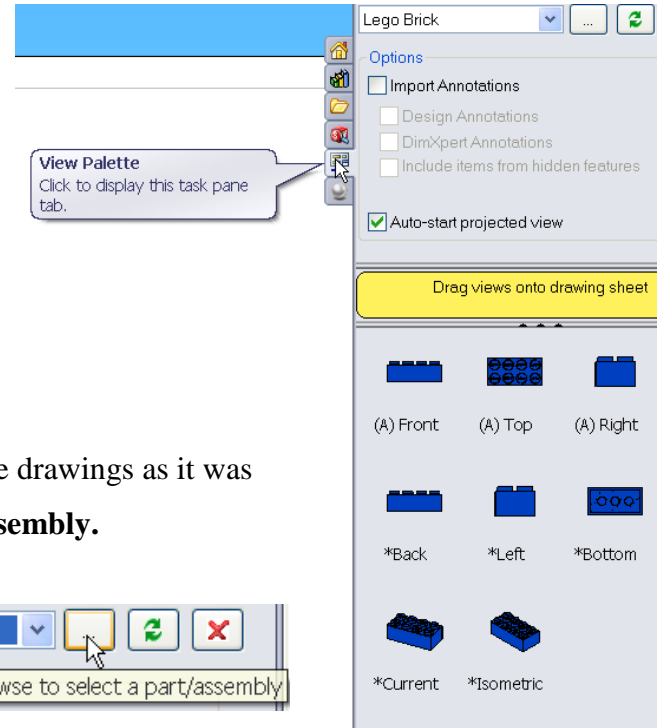

Lego Brick is chosen as the model from which to create the drawings as it was accessed when we selected **Make Drawing from Part/Assembly**.

A different model may be chosen using the browse feature.

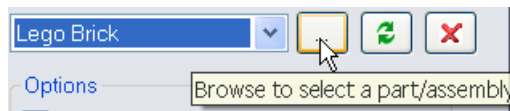

Importing drawing views.

Note: Ensure **Auto-start projected view** is ticked. This will allow us to project other views from the parent view.

Click and drag the **front view** from the view palette onto the drawing sheet.

By moving the cursor to the right an **end view** is projected from the parent view. Click to add the view.

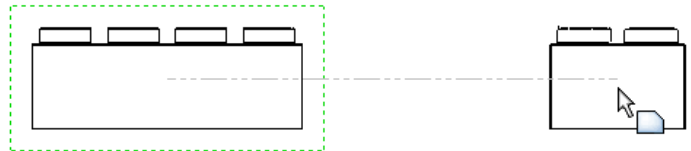

Project a plan view from the parent front view also.

Press Esc to stop **Auto-start projected view**



Drag an **isometric view** from the view palette.

Choose the front view (parent view) and change the **scale** to **3:1**.

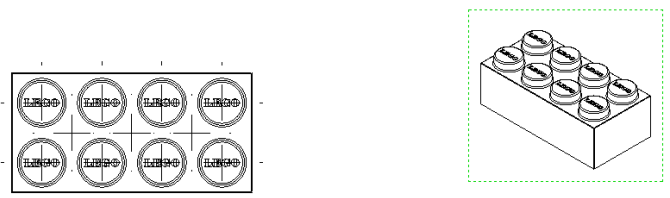

Note the end view and plan update to reflect the same scale but the isometric view doesn't. Why?

Because the end view and plan were projected from the front view they adopt the same scale. The isometric view was dragged from the view palette independently and hence keeps its original scale.

Note: When the views are dragged from the view palette they disappear from it and are no longer available.

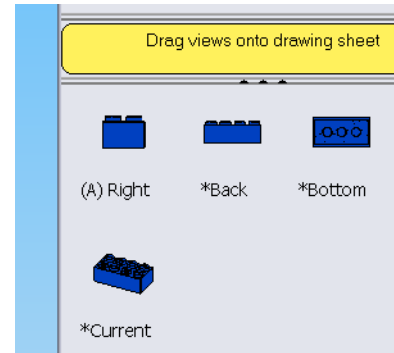

Adding dimensions

Choose **Model Items** from the annotations tab of the **commandmanager**



Choose the settings shown across. Choose **OK**

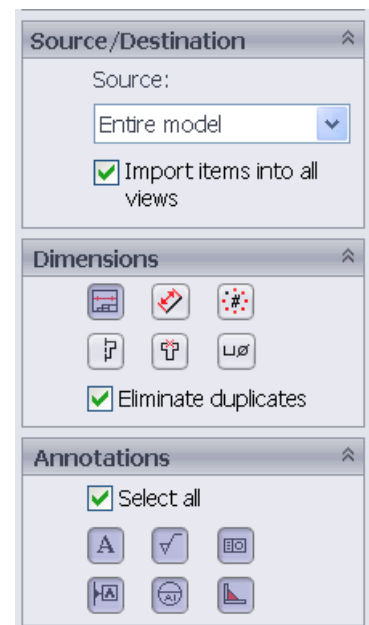
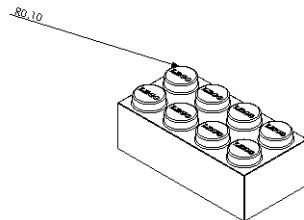
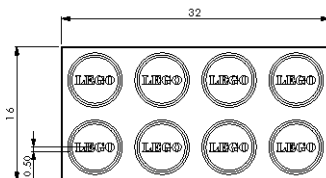
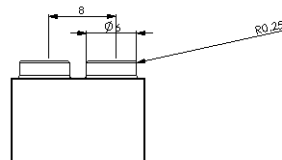
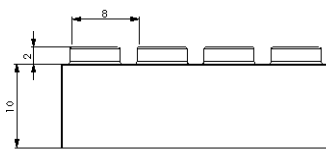

Drag the dimensions into the desired positions. Use Smart Dimension from the Annotation tab to add further dimensions if required.

Note The context sensitive toolbar may be accessed within the drawing environment at any stage by pressing **S** on the keyboard.

